

NARVA®

Part No. 71745

ULTIMA 215 MK3 SPOT LED DRIVING LIGHT INSTRUCTIONS AND SPECIFICATIONS



IMPORTANT SAFETY INFORMATION

Please read these instructions carefully before installation.

- Remove negative battery cable before installation.
- Ensure lamps are fitted using the appropriate wiring harness or an equivalent auxiliary wiring system.
- MK3 215 Spot (71745) can draw up to 23Amps of current at 10V per lamp, ensure wiring, fuse and relay used can handle high current and temperature depending on the length.

We strongly recommend to use the Ultima LED Wiring Harness (74407)

- Ensure the lamps are mounted securely to a solid surface on the vehicle or bullbar.
- Cables connected to the lamp must not be subjected to wear or other damage.

MOUNTING

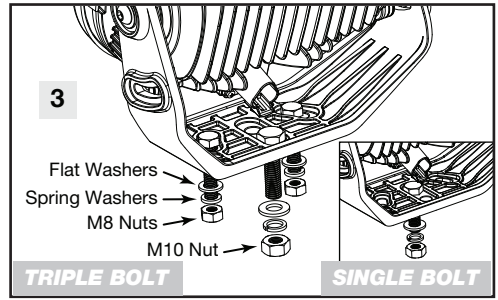
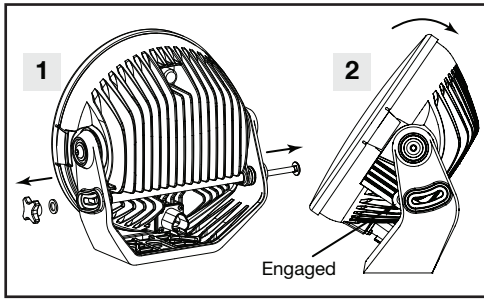

1. Remove Adjuster Knob, Flat Washer and Long Bolt.
2. Tilt lamp backwards to allow access to insert the mounting bolts (Ensure the lamp is still engaged with the bracket).
3. Place the mounting bolts through the holes in bracket. Note, 3 bolts are advised, if single bolt only, mount in centre hole.
4. Re-assemble the Adjuster Knob, Flat Washer and Long Bolt in reverse order.
5. Choose a solid surface on the vehicle or bullbar to mount the driving lights and secure the lamp by using flat washers, spring washers with M10 & M8 nuts.
6. Ensure the Adjuster Knob is done up tight.

ASSEMBLIES

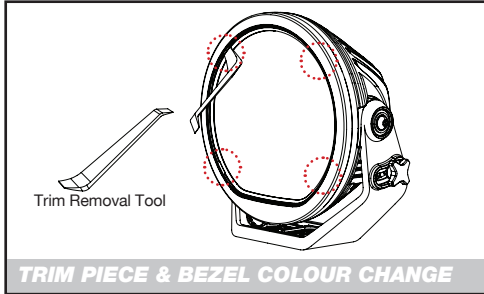

To change the colour trim or bezel, use the trim removal tool provided to lift up the bezel in the slits of each corner circled.

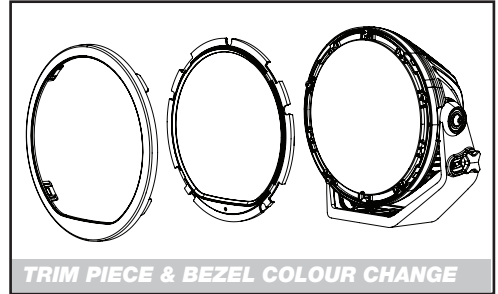

Re-assemble by simply snap locking the colour trim and bezel to the housing.

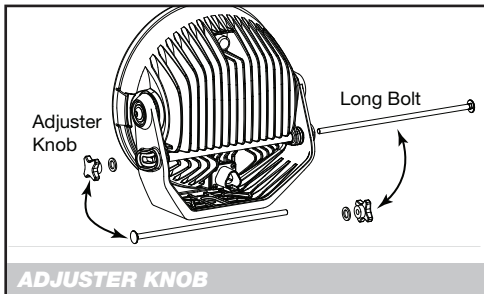

Adjuster Knob can be reversed from left hand to right hand side.

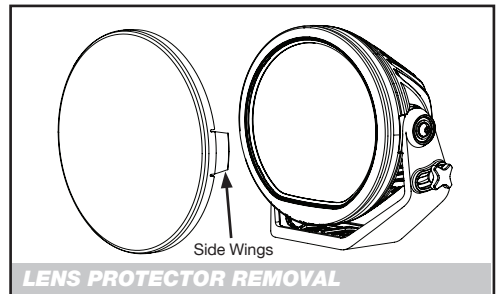

Remove Lens Protector by un-clipping the side wings.

ULTIMA LED SPOT WIRING HARNESS USING SWITCH & RELAY*

*Optional Wiring Harness (P/No. 74407)

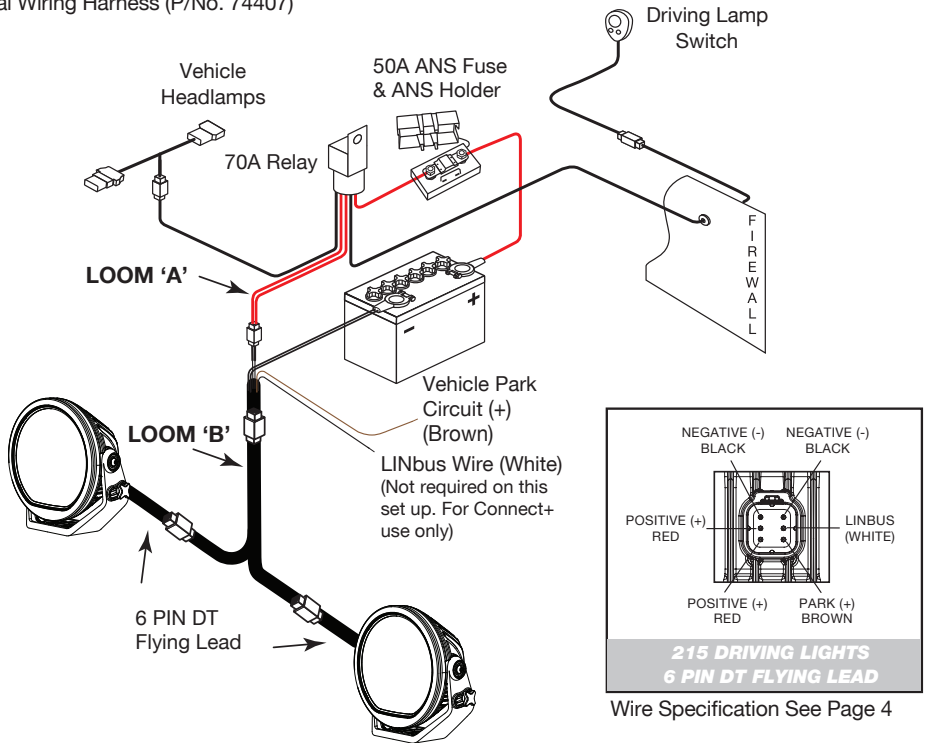

WARNING:

One wiring harness to be used per 2 driving lights. Additional lights connected to the same wiring harness will cause wiring and fuse to burn. MK3 215 Spot (P/No. 71745) can draw up to 23Amps of current at 10V per lamp, ensure wiring, fuse and relay used can handle high current and temperature depending on the length.

1. Connect Loom 'B' 6PIN DT connectors to 215 Driving Light DT flying lead sockets.
2. Fix Loom 'B' ground cable to chassis or battery (-).
3. Connect Loom 'A' to Loom 'B'.
4. Mount relay and fuse holder (Ensure these are mounted in a dry area of the engine bay)
5. Connect main positive cable with 70Amp relay from ANS fuse holder to battery (+).
6. Check the nuts on ANS fuse holder posts with ANS fuse fitted are securely tightened.
7. The kit is supplied with a pre-wired H4 loom assembly for direct connection to the vehicle headlamp high beam circuit. For globe types other than H4, an additional adapter kit (P/No. 74416) is available to suit H1, H3 and H7 globe types.
8. A direct connection from the vehicle high beam circuit to any alternate light source can be made by connecting the black wire to negative and red wire to positive.
9. Pass Loom 'A' 3 core lead through the firewall and connect to Driving Light Switch.
10. Test the driving light by turning on the vehicle's headlamps
The driving light should only illuminate on high beam.

Note: Driving lights must dip with H/Beam to meet ADR requirements. LINbus wire connection only required with Ultima Connect+ Controller. "High Beam Splitter" included if multiple wiring harnesses are used and require high beam feed.

ULTIMA 215 SPOT WIRING INSTRUCTIONS FOR CONNECT+ CONTROLLER INSTALL ONLY*

*Optional Wiring Harness (P/No. 74407)

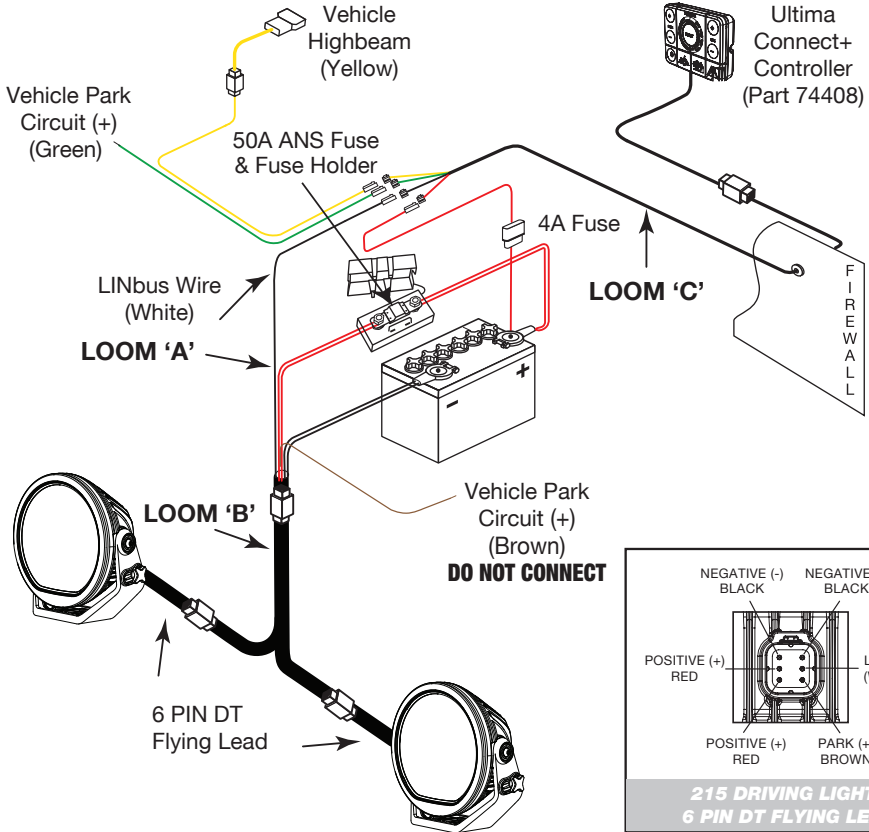

6-PIN DT FLYING LEAD WIRE SPECIFICATION

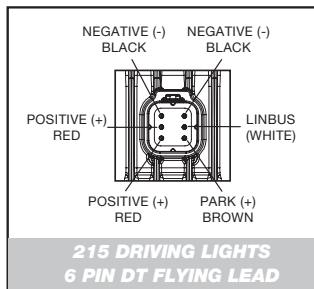

- PIN 1** Negative Black 4MM (16AWG)
- PIN 2** Linbus White 2.5MM (20AWG)
- PIN 3** Park Brown 2.5MM (20AWG)

- PIN 4** Positive Red 4MM (16AWG)
- PIN 5** Positive Red 4MM (16AWG)
- PIN 6** Negative Black 4MM (16AWG)

WARNING:

One wiring harness to be used per 2 driving lights. Additional lights connected to the same wiring harness will cause wiring and fuse to burn. MK3 215 Spot (P/No. 71745) can draw up to 23Amps of current at 10V per lamp, ensure wiring, fuse and relay used can handle high current and temperature depending on the length.

1. Connect Loom 'B' 6PIN DT connectors to 215 Driving Light DT flying lead sockets.
2. Fix Loom 'B' ground cable to chassis or battery (-).
3. The kit is supplied with a pre-wired H4 loom assembly for direct connection to the vehicle headlamp high beam circuit. For globe types other than H4, an additional adapter kit (Narva P/No. 74416) is available to suit H1, H3 and H7 globe types.
4. A direct connection from the vehicle high beam circuit can be made by connecting to the yellow wire from Loom 'C' of the Connect+ harness. Use yellow "High beam adapter extension" if extra length is required.
Note: See below for Negative Switching instructions
5. Connect the Green wire from Loom 'C' Connect+ harness to vehicle park light circuit or ignition source (+).
Note: Do not connect Park (+) Brown wire from 215 Driving Light when using Connect+
6. Connect white LINbus wires from Loom 'B' to Loom 'C'. If using 2 or more harnesses, use the white LINbus wire splitter. Every Connect+ enabled product will need to be connected to the white LINbus wire for full functionality.
7. Pass Loom 'C' through the firewall and connect to Connect+ Controller.
8. Remove the ANS Fuse Holder and 50A ANS Fuse from switch & relay harness. Locate the **two** red positive cables labeled "TO ANS FUSE HOLDER FOR CONNECT+ USE ONLY" and "TO ANS FUSE HOLDER" terminate to either end of ANS fuse holder with 50A ANS fuse fitted.
Note: Check the nuts on ANS fuse holder posts with ANS fuse fitted are securely tightened.
9. Connect main red positive cable with 50Amp ANS fuse in-line to Loom 'B'. **Do not use relay harness for Connect+ install.**
10. Connect red positive cable with 4Amp fuse in-line to Loom 'C' Connect+ harness.
11. Mount fuse holder (Ensure these are mounted in a dry area of the engine bay).
12. Connect all red positive cables to battery (+) from Loom 'A' and Loom 'C'.
13. Test the Connect+ controller by turning vehicle ignition or parking lights on. Power button on Connect+ should illuminate white.
14. Test the driving lights by turning on the vehicle's park light and high beams. Press the Power button on Connect+ when illuminated green to turn driving lights on. The driving lights should only illuminate on high beam.

Note: Driving Lights must dip with H/Beam to meet ADR requirements. LINbus wire connection only required with Ultima Connect+ Controller.

NEGATIVE SWITCHING

For negative switched vehicles:

1. Using a 4PIN normally open relay (Narva P/No. 68000), connect PIN 30 and PIN 85 to a constant +12V source with 5Amp inline fuse.
2. Connect negative (-) high beam wire from vehicle to PIN 86.
3. Connect PIN 87 to Connect+ Controller High beam feed.

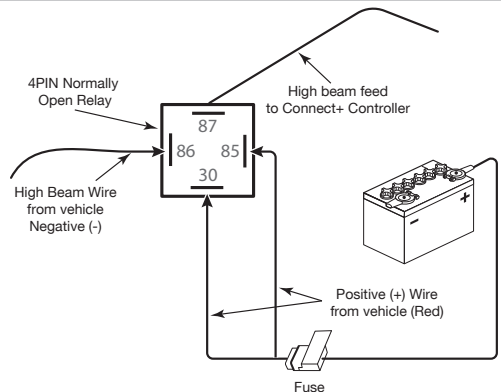

HOW TO USE CONNECT+ CONTROLLER

MAIN

Controls:

180 Ultima Hybrid Driving Lights
215 Ultima Hybrid Driving Lights
24" Ultima Light Bars

Press + to increase brightness
Press - to decrease brightness

BOOST

Overrides all modes and thermal protection system for 30 seconds to provide full brightness with an extra 15% power.

BOOST mode will turn off automatically after 30 seconds and cannot be pressed again until 5 minutes later. The boost ring lights up when ready to use

POWER

White illumination –
Ignition or Parking
lights ON

Green illumination –
High beam ON

Press to turn lights
ON and OFF when
green lights is
illuminated



AUX

Controls:

215 Ultima Spot Driving Lights
8" Ultima Light Bars

Press + to increase brightness
Press - to decrease brightness

DIRT ROAD MODE

Provides 100% brightness on
all lights

4WD TRACK MODE

Provides 50% brightness on
MAIN and 100% brightness
on AUX

HIGHWAY ROAD MODE

Provides 100% brightness on
MAIN and 50% brightness
on AUX

TECHNICAL SPECIFICATIONS - FOR 71745

Voltage:	12/24 Dual voltage with reverse polarity protection
LEDs:	33 x 10W CREE LEDs
Housing and Bracket:	Pressure die-cast aluminium housing and bracket
Beam Type:	Hybrid Beam Pattern
Lens:	Polycarbonate
Colour Temperature:	5700°K
Current Draw (per lamp):	20.6A at 13.5V

PARTS AVAILABLE

74407	Ultima LED Wiring Harness to suit 71732, 71734, 71742, 71744 and 71745
72224	Ultima 215 LED – Lens Protector Clear
72224BK	Ultima 215 LED – Lens Protector Black
72224BLK	Ultima 215 LED - Alternate LED Protector
72224YW	Ultima 215 LED - Lens Protector Selective Yellow
74145B	Ultima 215 LED – Metal Bezel (Black)
74145S	Ultima 215 LED – Metal Bezel (Satin)
74147	Bullbar adaptor plate kit
74444	Ultima 215 LED – Adjustment Bolt and Knob
74444BK	Ultima 215 LED – Adjustment Bolt and Knob Black
74445	Ultima 215 LED – Bracket Kit

WARRANTY STATEMENT

Brown & Watson International Pty Ltd ("BWI") of 1500 Ferntree Gully Road, Knoxfield, Vic., telephone (03) 9730 6000, fax (03) 9730 6050, warrants that all products described in its current catalogue will under normal use and service be free of failures in material and workmanship for a period of three (3) years from the date of the original purchase by the customer as marked on the invoice. This warranty does not cover ordinary wear and tear, abuse, alteration of products or damage caused by the purchaser. To make a warranty claim the consumer must deliver the product at their cost to the original place of purchase or to any other place which may be nominated by either BWI or the retailer from where the product was bought in order that the warranty assessment may be performed. The consumer must also deliver the original invoice evidencing the date and place of purchase together with an explanation in writing as to the nature of the claim. In the event that the claim is determined to be for a minor failure of the product then BWI reserves the right to repair or replace it at its discretion. In the event that a major failure is determined the consumer will be entitled to a replacement or a refund as well as compensation for any other reasonably foreseeable loss or damage. This warranty is in addition to any other rights or remedies that the consumer may have under State or Federal legislation.

IMPORTANT NOTE

Our goods come with guarantees that cannot be excluded under the Australian Consumer Law. You are entitled to a replacement or refund for a major failure and compensation for any other reasonably foreseeable loss or damage. You are also entitled to have the goods repaired or replaced if the goods fail to be of acceptable quality and the failure does not amount to a major failure.

Distributed by

AUSTRALIA

Brown & Watson International Pty. Ltd.

Knoxfield, Victoria 3180

Phone: (03) 9730 6000

Fax: (03) 9730 6050

National Toll Free: 1800 113 443

NEW ZEALAND OFFICE

Brown & Watson International NZ Ltd.

Mount Wellington, Auckland 1060

Phone: (09) 525 4575